

ECO E II

GREENLED

[FI] Asennusohje
[UK] Installation instruction
[SE] Installationsanvisning
[DE] Montageanleitung

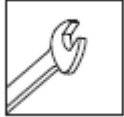

Eco E II 34 W	Eco E II 52 W	Eco E II 68 W	Eco E II 92 W*
GL99340	GL99520	GL99680	GL99920
34 W	52 W	68 W	92 W
4700 lm	6600 lm	9500 lm	12000 lm

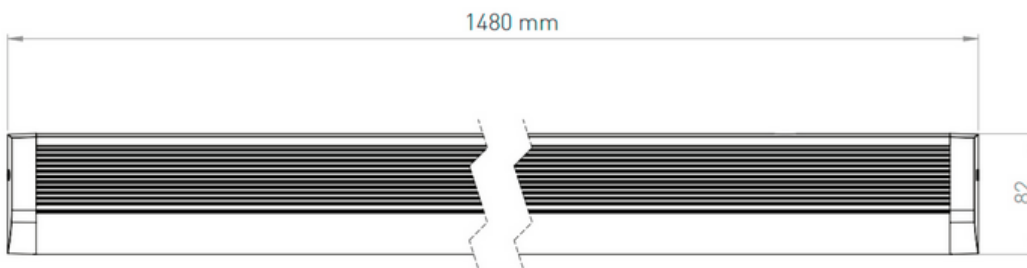
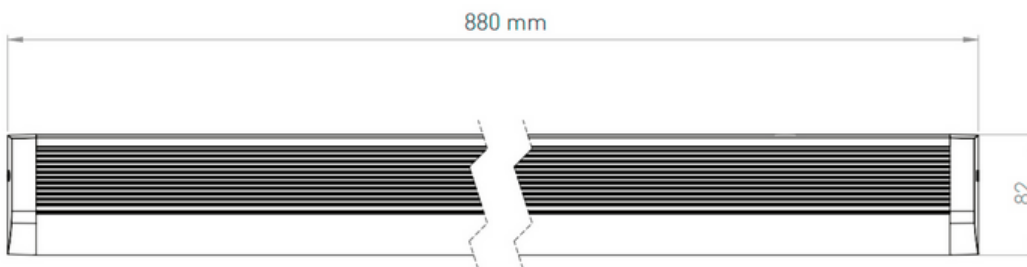

DOC00358, 1-ASENNUSOHJE, ECO E II

GREENLED



Turvallisuusvaroitukset:

Ennen asennusta tai huoltotyötä kytke valaisin irti sähköverkosta välttääksesi sähköiskun vaaran!

- Asennus / huoltotyön saa tehdä vain valtuutettu henkilö
- Valaisimen asennuksen / huoltotyön saa suorittaa vain pätevä henkilö näiden ohjeiden mukaisesti.
- Valmistaja ei kannu vastuuta valaisimen väärästä käytöstä
- Älä katso suoraan päällä olevaan valaisimeen
- Valaisimen valonlähteen saa vaihtaa ainoastaan Greenled, Greenledin valtuuttama huoltaja tai vastaavan pätevyyden omaava henkilö



Safety notes:

Before installation or change work disconnect the power to reduce electrical shock risk!

- Installation / maintenance can only be done by a skilled personnel
- Installation / maintenance of luminaire must be performed by qualified person following the instructions given in the instruction set
- The manufacturer bears no liability for damage caused by inappropriate use or application
- Do not stare at the operating light source
- The light source contained in this luminaire shall only be replaced by the Greenled or Greenled's service agent or a similar qualified person



Säkerhetsvarningar:

Koppla alltid bort armaturen från elnätet i samband med installation ti den som använder armaturen.

- Installations- och underhållsarbeten får endast utföras av en behörig installatör
- Installations-/underhållsarbetet får endast utföras enligt dessa anvisningar av en person med tillräckliga kunskaper
- Tillverkaren ansvarar ej för felaktig användning av armaturen
- Titta aldrig rakt in i en påslagen armatur
- Ljuskällan inuti armaturen får endast bytas av antingen Greenled, en Greenled-auktoriserad servicetekniker eller en person med motsvarande kompetens



Sicherheitshinweise:

Vor Montage- und Wartungsarbeiten ist die Leuchte vom Stromnetz abzutrennen, um einem Stromschlag vorzubeugen!

- Die Montage-/Wartungsarbeit darf nur von einer bevollmächtigten Person durchgeführt werden
- Montage- und Wartungsarbeiten an der Leuchte darf nur eine kompetente Person laut diesen Instruktionen durchführen.
- Der Hersteller übernimmt keine Verantwortung für eine falsche Nutzung
- Schauen Sie nicht direkt in eine brennende Leuchte
- Die Lichtquelle der Leuchte darf ausschließlich durch Greenled, einen von Greenled beauftragten Wartungsinstallateur oder eine Person mit entsprechender Kompetenz ausgetauscht werden.

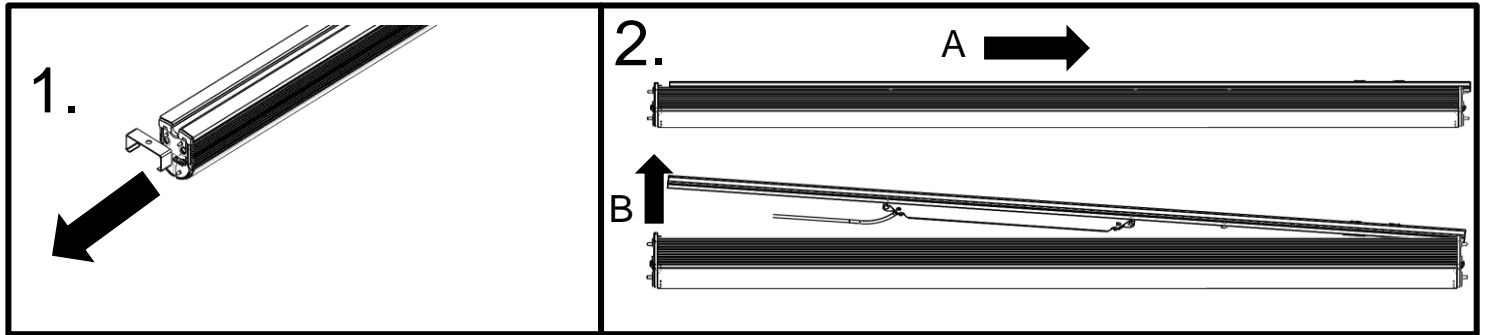
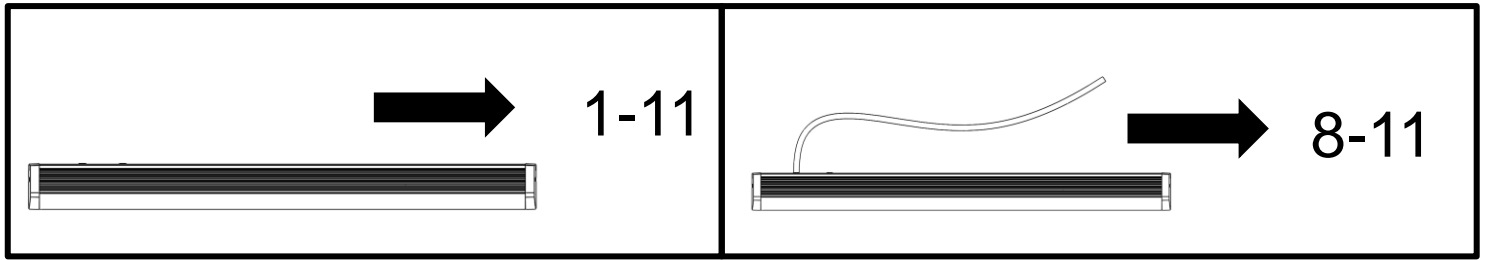

! Ohjauspiirin on oltava peruseristetty verkkojännitteestä | The control circuit must be basic insulated from the mains voltage
 Styrkretsens måste vara grundisolerad från nätspänningen | Der Steuerkreis müssen Basisisolierung gegenüber der Netzspannung haben

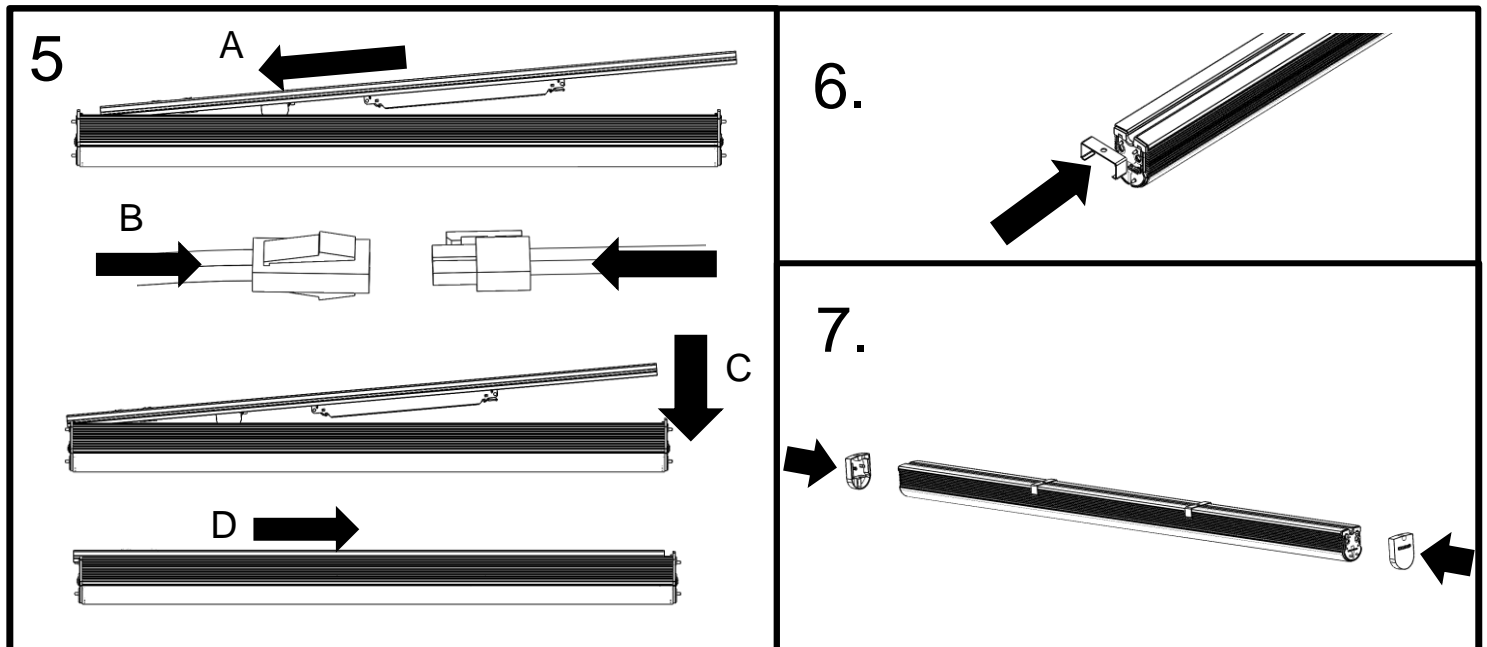
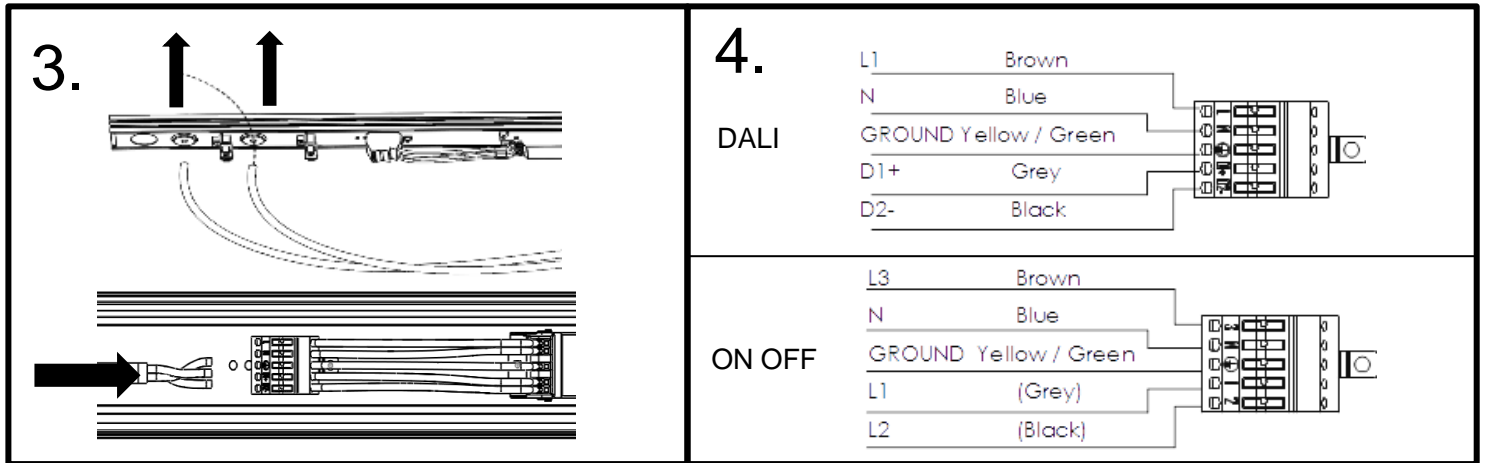

8. Kattoasennus, Surface installation, Takmontering, Dachmontage

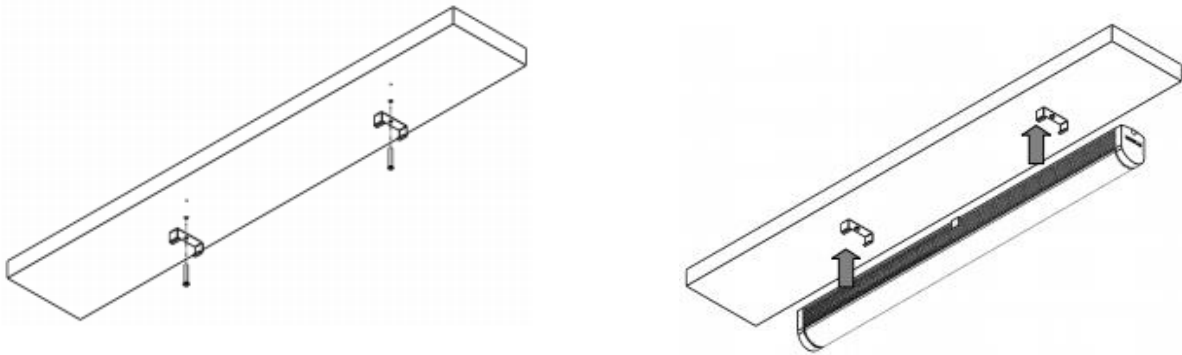
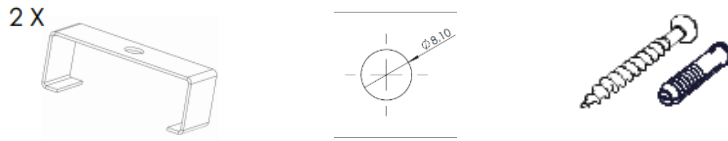

9. Valaisinkisko, Suspension Rail, Belysningsskena, Leuchtenschiene

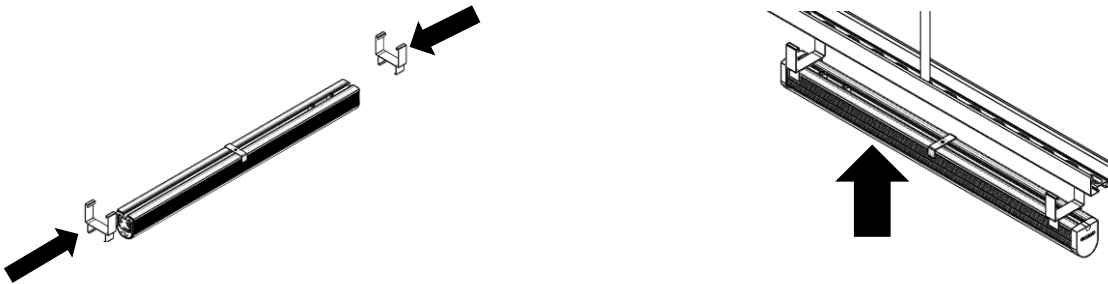

10. Vaijerikiinnitys, Wire installation, Vajerupphängning, Seilbefestigung

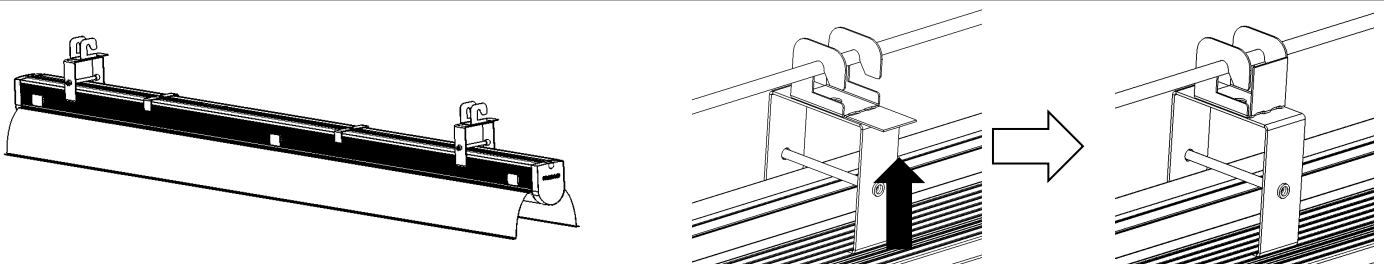
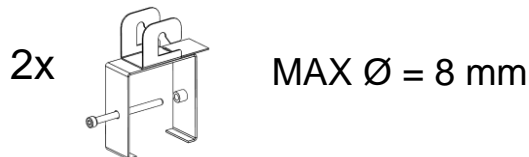

11. ECO E II Plus (60° / 80° / 100°)

6x

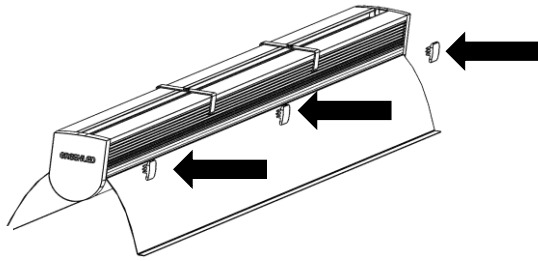
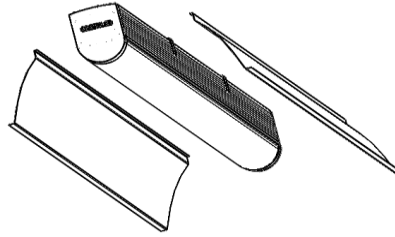

"snap"

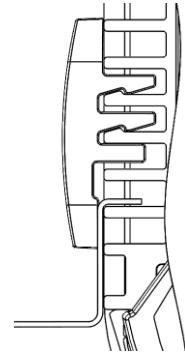
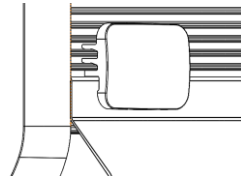

FI

Nämä ohjeet tulee säilyttää ja luovuttaa kiinteistön käyttäjälle.

UK

It is appropriate that this information is passed on to the user of the installation.

SE

Det är lämpligt att denna information överlämnas till användaren av anläggningen.

DE

Diese Informationen sind für den Benutzer der Anlage vorgesehen.



PC

